



UVC disinfection systems



TECHNICAL & USER MANUAL



This manual is subject to change without further notice. No rights can be derived from this manual. No part of this manual may be reproduced, in any form or by any means, without prior written consent from AED Distribution NV, Belgium.

Luxibel® is a registered trademark of AED Distribution NV.

Luxibel® - 2020 - www.luxibel.com

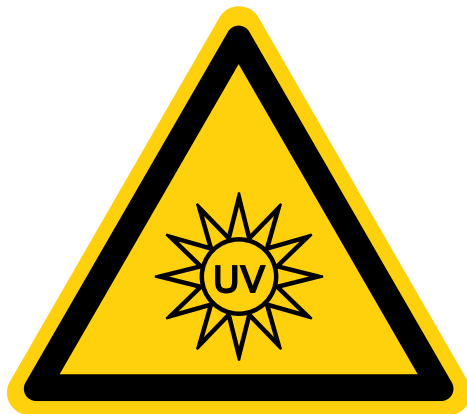

CAUTION UV LIGHT

The product as described herein contains components that emit UVC light. Immediate or prolonged exposure to UVC light can result in painful injury such as eye injury, skin burn, premature skin aging or skin cancer.

Do not use the product before carefully reading this manual.

Always keep this manual with the product and consult it regularly.

1. Using this manual - general

This manual (hereinafter referred to as the "Manual") is intended to be used as work of reference for professional, well trained and authorised users to be able to safely install, use, maintain and repair the product mentioned on the cover of this document (hereinafter referred to as the "Product"). The observation of the Manual does not dispense the user from the observance of the local safety instructions and regulations other than provided by the Manual. Such safety instructions and regulations must be observed at all time.

For information about specific adjustments, maintenance or repair jobs which are not dealt with in this manual, please contact your Product supplier or Luxibel.

If you suspect that the Product is damaged or detect a potential or actual danger when using the Product, immediately discontinue use of the Product and contact your supplier of the Product.

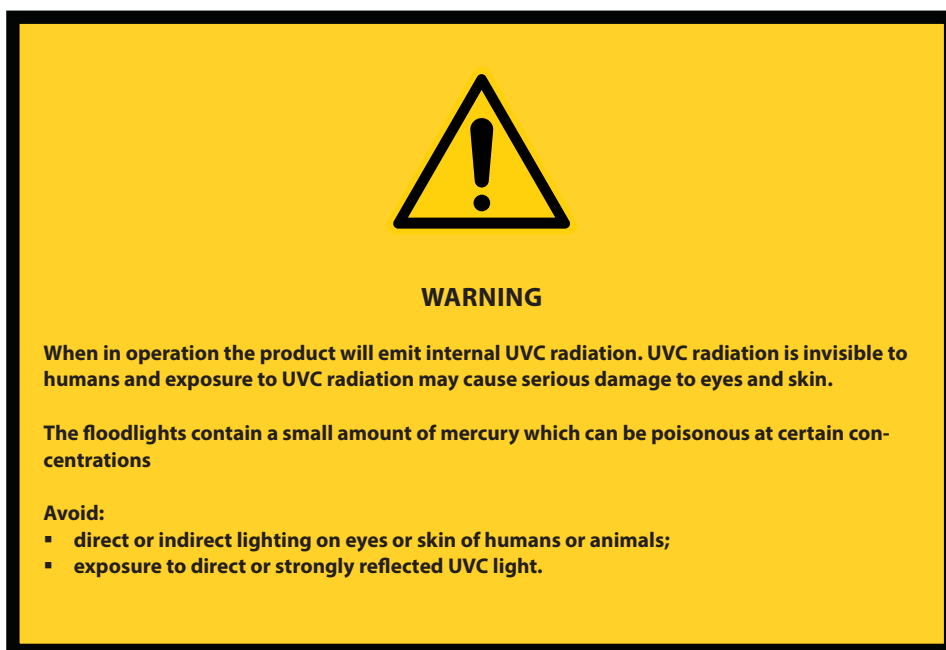

Basic safety instructions

To minimise the risk of injury, the following basic safety precautions should be observed with each use of the product:

1. Before use, read and save all notices, warnings and safety instructions received with the Product;
2. Before each use, inspect the Product for damage and verify the proper functioning of its safety features; do not operate the Product if in case of actual or suspected damage or if its safety features do not function properly;
3. Select Product mounting locations that prevent exposure of persons and vulnerable components to the UVC-light, such as by placing the on/off switch elsewhere than in direct exposure to UVC-Light. If that is not possible, minimize the exposure to UVC-light and use adequate personal protection and protect vulnerable components with UV resistant material;
4. Before performing any service or maintenance always unplug the Product and disconnect the power supply;
5. Manage the disposal of the Product and in particular of the floodlights with care and according to your local disposal laws;
6. In case of actual or suspected damage to the floodlights, immediately ventilate and leave the room until it is ventilated;
7. Place warning signs near all access panels or doors to a space containing the Product;

8. Do not:

- operate the Product without proper electrical grounding;
- wash the Product with water under pressure or by immersion;
- alter the construction or design of the Product and do not remove any safety labelling or devices;
- use the Product for other than its intended purposes, as described in the Manual.

2. Disclaimers

Luxibel, being AED DISTRIBUTION NV, with registered office at Bedrijvenpark De Veert 13/4, 2830 Willebroek (Belgium), or any of its affiliates, does not accept any liability for material damage, including damage to the Product, or personal injury caused by non-observance by the user of the safety instructions in the Manual or the applicable laws. As such Luxibel shall among others not be liable for any damage or injury if the Product is used contrary to or for purposes other than its intended use, is installed, used, maintained or repaired negligently or contrary to the instructions mentioned in the Manual or on the Product, when the Product is modified and when the safety devices and features of the Product are disregarded or overridden.

3. Safety instructions and warnings

3.1 User manual

Every person using the Product must read, familiarize them self and understand the contents of the Manual before any use of the Product and must strictly observe the instructions set out herein. If you are an employee or are acting on behalf of another person, your employer/that person must instruct you in accordance with the Manual and ensure that all instructions set out herein are complied with. Please do not use the Product if that is not the case.

To ensure the safe use of the Product this Manual must always be kept with the Product in legible condition.

3.2 Intended use and installation

The Product is intended exclusively for air disinfection. Using the Product for other purposes is contrary to its intended use and is done at own risk.

To ensure safe use of the Product, its installation, including all of its safety features and devices, and its maintenance and repair must be carried out correctly by duly skilled and authorised persons. All of the Product safety features and devices must be mounted and may not be removed but for the purpose of maintenance and repair.

The Product is not intended to be used by minors. Any use of the Product by minors, regardless whether or not under the supervision of an adult, is at own risk.

3.3 Safety features & devices of the Product

Each Product is equipped with the following safety features and devices, including devices disconnecting the power supply in certain circumstances for the purpose of avoiding accidental exposure to UVC-light:

- Sound alarm: during operation a continuous sound will be emitted from the unit
- Visible alarm: embedded RED led works continuous during operation off the unit
- Motion sensor: if any motion is detected , the motion sensor will turn off the unit

It is strictly forbidden to override these safety devices or to use the Product if the safety features are not fully present or disfunction. The safety features should be regularly checked for their proper functioning, and if required, be immediately repaired or replaced.

The pictograms, warnings and instructions attached to the Product are part of its safety features. They must not be covered or removed and must be present and legible during the entire use of the Product. Immediately replace or repair missing, damaged or illegible pictograms, warnings and instructions.

3.4 Modification

Under no circumstances any modification of the Product may be done by any person other than Luxibel.

4. General characteristics and technical specifications

The Product is designed to emit UVC radiation with a wavelength of 253,6 nm, in order to eliminate 99% of viruses, bacteria, fungi and harmful microorganisms.

The UVC lamps are designed for approximately 9000 hours of efficient operation. UVC lamps used longer than this, may no longer emit the required level of ultraviolet radiation to ensure the desired effect on bacteria or fungi.

Technical data

| Type | B Square |
|------------------------|---|
| Voltage | 230 V; 50 Hz |
| Isolation | Class I (requires electrical grounding) |
| Light source | 2x PL-L 60W |
| Light source life time | > 9.000 hrs |
| Radiation | 253,7 nm |
| Power consumption | 124 W |
| IP class | IP20 |
| Coverage area | Up to 38 m ² |
| Reco disinfection time | < 15 min |
| Weight | 4,8 kg |
| Dimensions (W x D x H) | 595 x 595 x 80 mm |

Dimensions

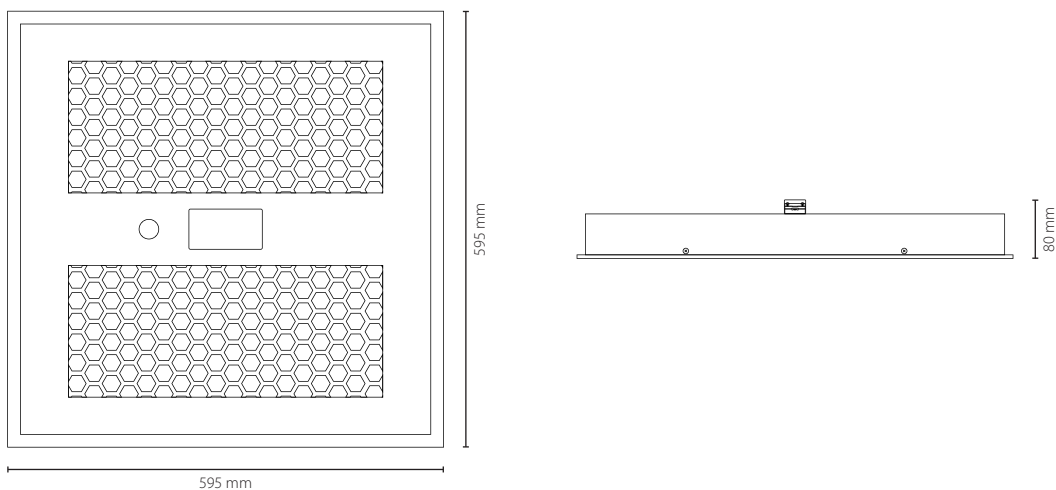

5. Construction and operation

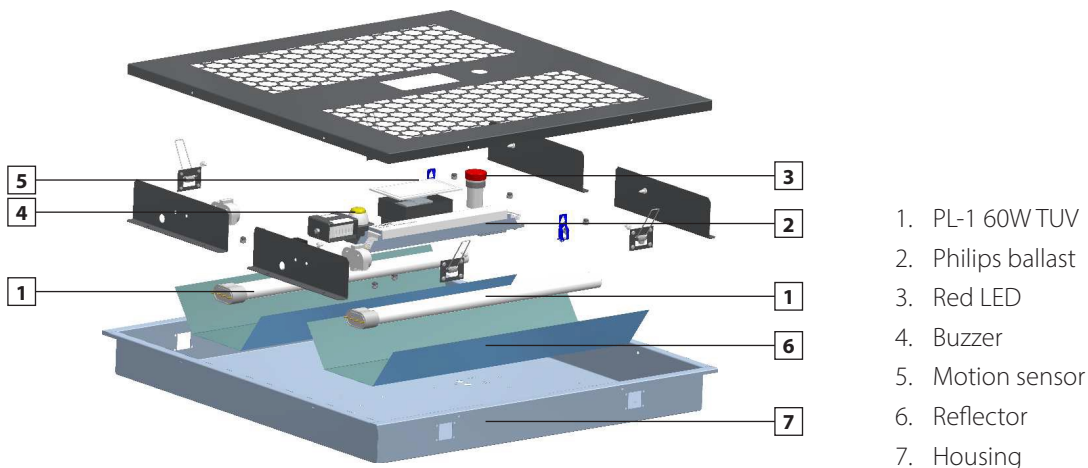

6. Installation of the product

Perform the following steps for the installation of the Product.



CAUTION: Electrical installation must be carried out correctly and by authorized electricians only.



Outside every room where direct UVC light is used, there must be warning signs in clear line of sight.
Extra signals can be added that specify the hours of use or other important relevant notifications

6.1 Choose the appropriate location

Choosing the appropriate location is important for the proper functioning and safe use of the Product.

Install the Product in a protected area where the temperature does not fall below 5° C and the humidity level is low. The Product functions ideally in a temperature range from 15°C to 25° C.

Select Product mounting locations that prevent exposure of persons and vulnerable components to the UVC-light, such as by placing the ON/OFF switch elsewhere than in direct exposure to UVC-Light. If that is not possible, minimize the exposure to UVC-light and use adequate personal protection and protect vulnerable components with UV resistant material.

Luxibel obliges placing the ON/OFF switches for the Product separate from general room lighting and only accessible by authorized and duly trained persons.

6.2 Remove the shipping assembly

Remove the tape from the box and open the box. Take the unit out of box and remove wrapping that protects the unit. Make a visual inspection of the unit.

6.3 Before installing the Product

Read and save all notices, warnings and safety instructions received with the Product. Inspect the Product for damage and verify the proper functioning of its the safety features. Do not operate the Product if in case of actual or suspected damage or if its safety features do not function properly.

6.4 UVC Lamp Installation

Perform the following procedure to install the UVC lamp using gloves:

1. Insert the lamp with the dowels into the slots of the holders and rotate it about 90 degrees around the axis.
2. Clean the lamp after handling with 99% isopropyl alcohol and a lint free cloth.



CAUTION: Do not touch the lamp without gloves. Damage to the lamp may result. Oil from fingerprints will permanently etch the glass of the lamp and weaken the structure.

6.5 UVC fixture installation

B Square is easily mounted into standard recessed modular ceilings. The dimensions are 595 x 595 mm and are exactly the same as the ceiling tile. Best to remove the springs with pliers.

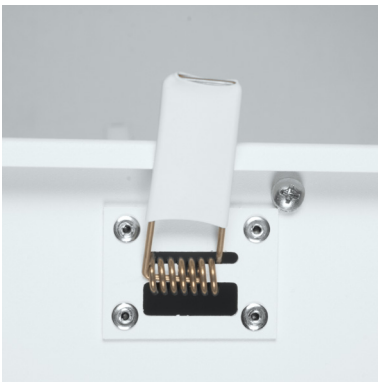

For non modular recessed ceilings a square hole must be cut of: 580 x 580 mm, gently push the springs over the ceiling and compress the other side's springs. Insert the unit into the cut whole.

6.6 Wiring the Product to power source

UVC lamps must be operated continuously from a separate, dedicated, 220-240 V power source.



Ensure main power is disconnected prior to connecting the unit or making any changes to cabling configurations.



Electrical installation must be carried out correctly by authorized electricians.

Standard: 230V 50Hz

Brown = Line cable

Yellow green = Earth cable ⊕

Blue = Neutral cable



This device is a class 1 electrical isolation and must be earthed.

6.7 Testing the Product

Test the Product before putting it to use. While lit, the UVC lamp should emit green/blue light. If the UVC lamp colour changes to red or if the lamp flickers, the lamp will no longer emit the required level of ultraviolet radiation to ensure the desired effect on bacteria or fungi.

If the UVC lamp colour changes to red or if the lamp flickers, replace the lamp.

6.8 Operation of the unit

When power is put on the main leads according to electrical specifications, the unit will turn on.



The control method for direct UVC cannot be in the same room as the units and should be installed in such a way that only authorized persons can control it.



All employees attending the building must be informed of the use of direct UVC light, and how it's safety features work.

An informational Video will soon be at your disposal to explain this easily. This can be used to explain the employees the working of the uvc installation. See www.luxibel.com for more information.



A responsible and authorized person must be appointed for operating and maintaining the installation correctly.



The responsible person must be trained and educated about the use and risks of UVC.



Do not radiate UV-C light on humans and animals! UVC radiation can be harmful to skin and eyes.

The installation can only be powered on when **NO humans or animals** are present in the room. When manual operated, the room must be checked and locked before UVC lights can be powered on. Automation of UVC lights can only be done in controlled environment and must be implemented in such way that no people or animals can be in this room during operation.

Understanding the units operation:

Once B Square is powered on:

- Motion sensor will be activated
- Sound alarm will be activated and alarm continuously
- Led will light up continuously



As long as the unit is under operation you will be hearing an alarm and you can see the led flashing. You cannot enter the room.

If somebody does enter the room. The motion sensor (360°) will detect the movement and Within 20ms after detection, the unit will be powered off. Once motion sensor is interrupted the unit will not power itself back on. The power to the unit needs to be interrupted by authorized person to restart the unit.

7. Product failure

| Failure | To Do |
|----------------------|--|
| unit doesn't work | check incoming power check cable for damage check if lamp is correctly installed |
| unit flickers | check if lamp is correctly installed replace lamp |
| alarm doesn't work | reset the unit |
| red LED doesn't work | reset the unit |

If the failure is unsolved or recurring, please return the unit to an official Luxibel dealer / service center for repair or replacement. (see 10. repair)

8. Cleaning and maintenance

Clean and replace the lamps at the required service intervals.

Before performing any service or maintenance always unplug the Product and disconnect the power supply.

Clean the external surfaces with a soft cloth and non-aggressive cleaning agents only. Clean the UVC lamps using alcohol wipes and a lint free cloth only.



CAUTION: Turn off and lock out ALL unit power before performing any maintenance, service or cleaning. Do not wash the Product with water under pressure or by immersion. Do not touch the lamp without gloves.



CAUTION: Appropriate PPE equipment should be worn any time when there is a possibility of eye contact with the light emitted by the UV-C lamps and/or of direct contact the light emitted by the UV-C lamps with the skin.

9. Replacement of the UVC lamp

Luxibel recommends replacing the UVC lamp once a year and each time when its output falls below 80% of initial radiometer reading.

Following steps need to be taken for replacing a UVC lamp:

1. Unscrew 4x Philips screw on 2 sides of the B Square (red)
2. Take the front cover of the unit, be carefully for the LED power cable
3. Take out PL-L 60W TUV by unplugging the socket
4. Replace with new sources
5. Screw back front in position
6. Clean unit with dry cloth

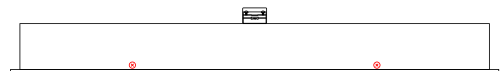

CAUTION: Always disconnect power to the Product before replacing the UVC lamp.

NOTE: Use only the original specified spare parts, including Philips UVC lamps. Use of other spare parts may result in damage to the Product.

10. Repairs

If the Product is damaged or malfunctions, contact the Luxibel Service Department or a Luxibel authorized distributor. Repairs by parties other than Luxibel or a Luxibel authorized distributor may not involve the use of Luxibel genuine parts and may affect the safety and functionality of the Product.

For repair options or specific inquiries, please contact the Luxibel Service Department.

Notes

All rights reserved. No part of this manual may be copied or published by means of printing, photocopying, microfilm or otherwise without the prior written consent of the manufacturer. This restriction also applies to the corresponding drawings.

The information given in this manual has been collected for the general convenience of our customers. It has been based on general data pertaining to construction material properties and working methods known to us at the time of issue of the manual and is therefore subject at any time to change or amendment, and the right to change or amend is hereby expressly reserved. The instructions in this manual only serve as a guideline for installation, use, maintenance and repair of the product mentioned on the cover page of this document. This manual is to be used for the standard model of the product of the type given on the cover page. Thus the manufacturer cannot be held responsible for any damage resulting from the application of this manual to any other product.

This manual has been written with great care. However, the manufacturer cannot be held responsible, either for any errors occurring in this manual or their consequences.



AED Distribution NV

Bedrijvenpark De Veert 13/004, 2830 Willebroek, Belgium
+32 3 860 76 50 | info@luxibel.com

www.luxibel.com

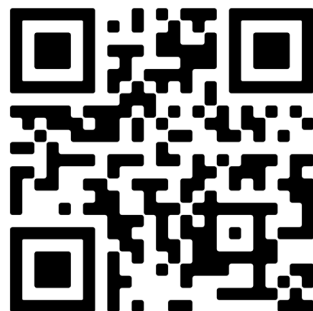

www.AEDgroup.com